

Pacific Antenna Two Tone Generator



Description

Our Two Tone Generator kit provides two non-harmonic, sine wave signals for testing audio circuits

Outputs of approximately 700Hz and 1900Hz and the combination of these two signals.

Adjustable amplitude and balance.

Designed for testing audio circuits, especially voice and digital mode radios.

Comes complete with all electrical and mechanical components.

Detailed instructions and all through hole components for straightforward assembly.

Powered by two 9 volt batteries, (not included).

TONE 1: Typically 1950Hz +/-50Hz at approximately 5Vpp

TONE 2: Typically 750Hz +/-50Hz at approximately 5Vpp

COMBINED: Combination of Tone 1 and Tone 2 adjustable from approximately 1mV to over 8Vpp.

Balance control: adjusts the relative levels of Tone 1 and Tone 2 in the combined output

Level control: adjusts the level of the combined tone signal output

Recommended Tools

- Temperature Controlled Soldering Station with small tip
- Solder, 60/40 or 63/37 Tin-Lead recommended
- Small Diagonal Cutters
- Small Needle Nose Pliers
- Pencil, Pen, and/or Highlighter
- BRIGHT work light with magnifier
- Meter to measure current and resistance (typical DMM will be ok)
- Frequency counter
- Oscilloscope

Optional

- Solder Sucker or Solder Wick
- Knife or Wire Stripper
- Cookie Sheet to build in and keep parts from jumping onto the floor.
- Circuit board stand
- Oscilloscope
- Frequency Counter

Construction Techniques

- During the build you may find it helpful to print the manual for reference.
- The Parts List has columns for inventory and construction.
 - Use the first column to check the parts as you inventory them.
 - Use the second column to check the parts as you install them.
- Please take time to inventory the parts before starting. Report any shortages to QRPKITS.com for a replacement.
- Pre-sorting and identifying components will speed up the assembly and reduce mistakes.
- If you are a beginner, new to soldering, there are a number of resources on the web to help you get on the right track soldering like a pro. Google Soldering Techniques.
- Use a Temperature Controlled Soldering Station with small tip. Conical or very small screw driver tips are best.
- You can insert several parts at a time onto the board. When you insert a part bend the leads slightly to hold the part in place until it is soldered
- Double check that the parts are in the correct locations then flip the board over and solder all at the same time.
- After soldering, clip the leads close to the board
- Most parts should be mounted as close to the board as possible. Transistors should be mounted about 1/8" above the board.
- Solder one lead on ICs or IC sockets and then check to make sure the component is seated and flush then solder a lead on the opposite end and recheck before soldering the remaining leads.
If the package is not seated on the board, apply gentle pressure to the IC or socket and heat the lead on the end(s) not seated to the board

Typical Parts

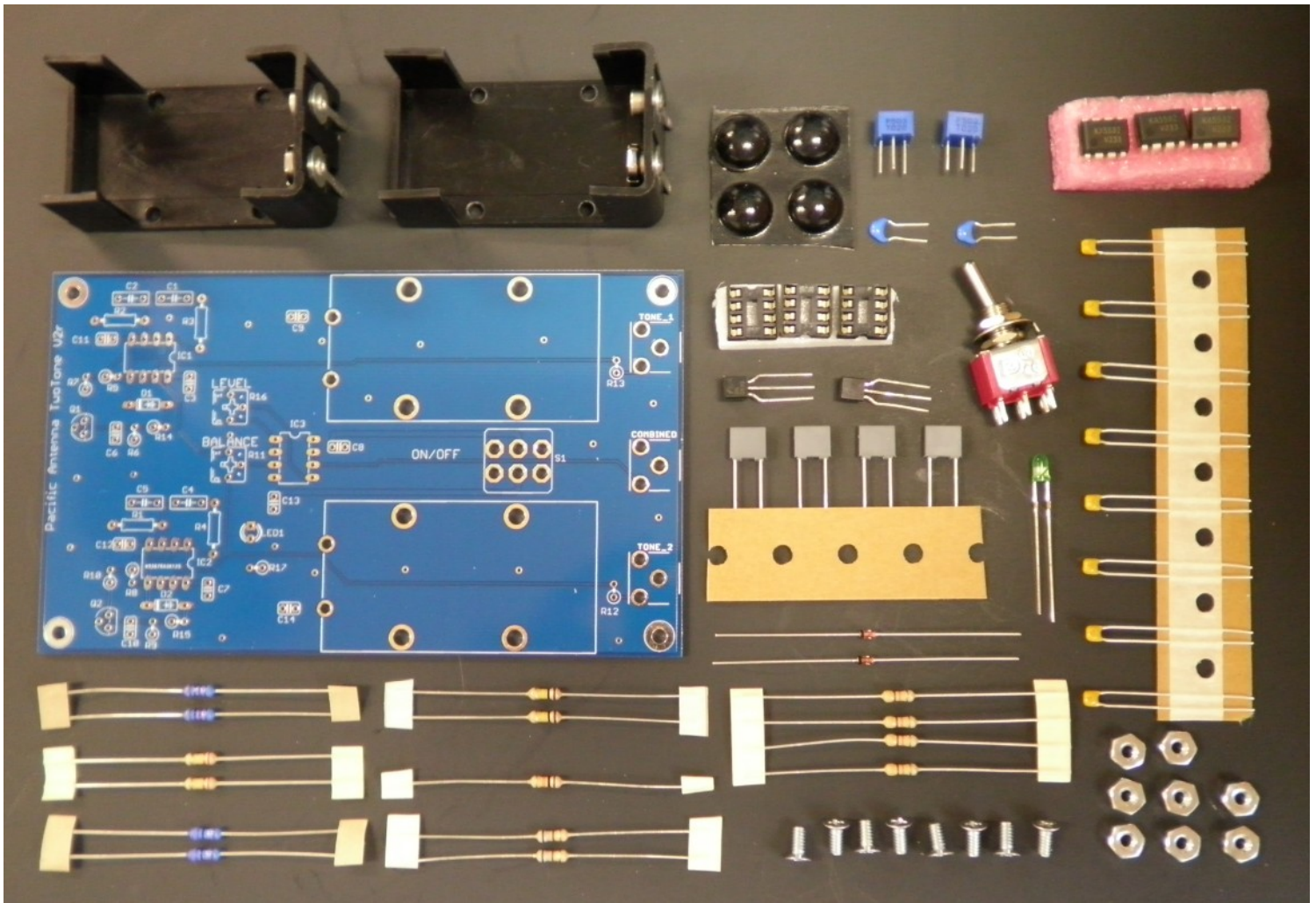

Note: Parts may occasionally vary from this photo due to source changes so always verify the part value and type before soldering in place.

Parts List

Qty	Parts	Value	Description
1	LED1	LED	LED, 3MM Green,
2	D1, D2	1N4148	DIODE, small glass encapsulated
8	C3, C7, C8, C9, C11, C12, C13, C14	0.1uF	CAPACITOR, mono 0.1 lead spacing. Labeled 104
2	C6, C10	0.47uF	CAPACITOR, mono 0.1 lead spacing. Labeled 474
4	C1, C2, C4, C5	1nF	CAPACITOR, Film box, Label 1000pF, or 102
2	R12, R13	680 Ohm	RESISTOR, 1/4 W, 5%. BLU-GRY-BRN-GLD
1	R17	10K	RESISTOR, 1/4 W, 5%. BRN-BLK-ORG-GLD
4	R7, R10, R14, R15	47K	RESISTOR, 1/4 W, 5% YEL-VIO-ORG-GLD
2	R5, R8	100K	RESISTOR, 1/4 W, 5% BRN-BLK-YEL-GLD
2	R6, R9	220K	RESISTOR, 1/4 W, 5% RED-RED-YEL-GLD
2	R1, R4	220K	RESISTOR, 1/4 W, 1% RED-RED-BLK-ORG-BRN
2	R2, R3	82K	RESISTOR, 1/4 W, 1% GRY-RED-BLK-RED-BRN
2	R11, R16	50k	TRIMMER Labeled 503, small blue potentiometer
2	BT1, BT2	Holder	Battery Holder, 9V black plastic
1	S2	Switch	TOGGLE SWITCH, DPDT, ON-ON
2	Q1, Q2	2N3819	N-Channel JFET, T0-92, black plastic case
3	IC1, IC2, IC3	NE5532N	OPAMP, 8 pin DIP package
3	Sockets for ICs	IC Sockets	8 Pin IC sockets
3	Output connectors	RCA	RCA Jack, 2 black, one yellow or white
1	Circuit Board V2 or later	PCB	Board
4	Rubber feet	Black	Small black or clear rubber feet
8	4-40 Screws	Screws	4-40 flat head screws
8	4-40 Nuts	Nuts	4-40 hex nuts
1	Adapter to BNC	Adapter	RCA to BNC Adapter

Board Layout

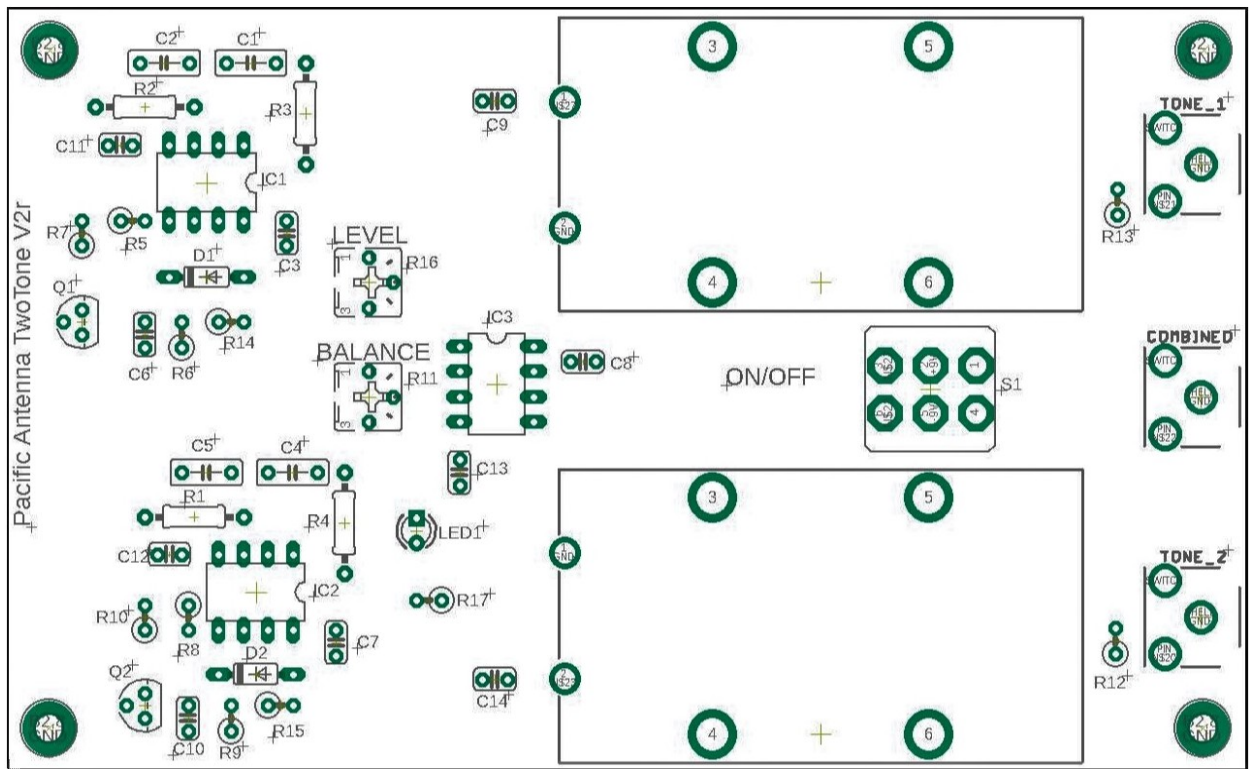
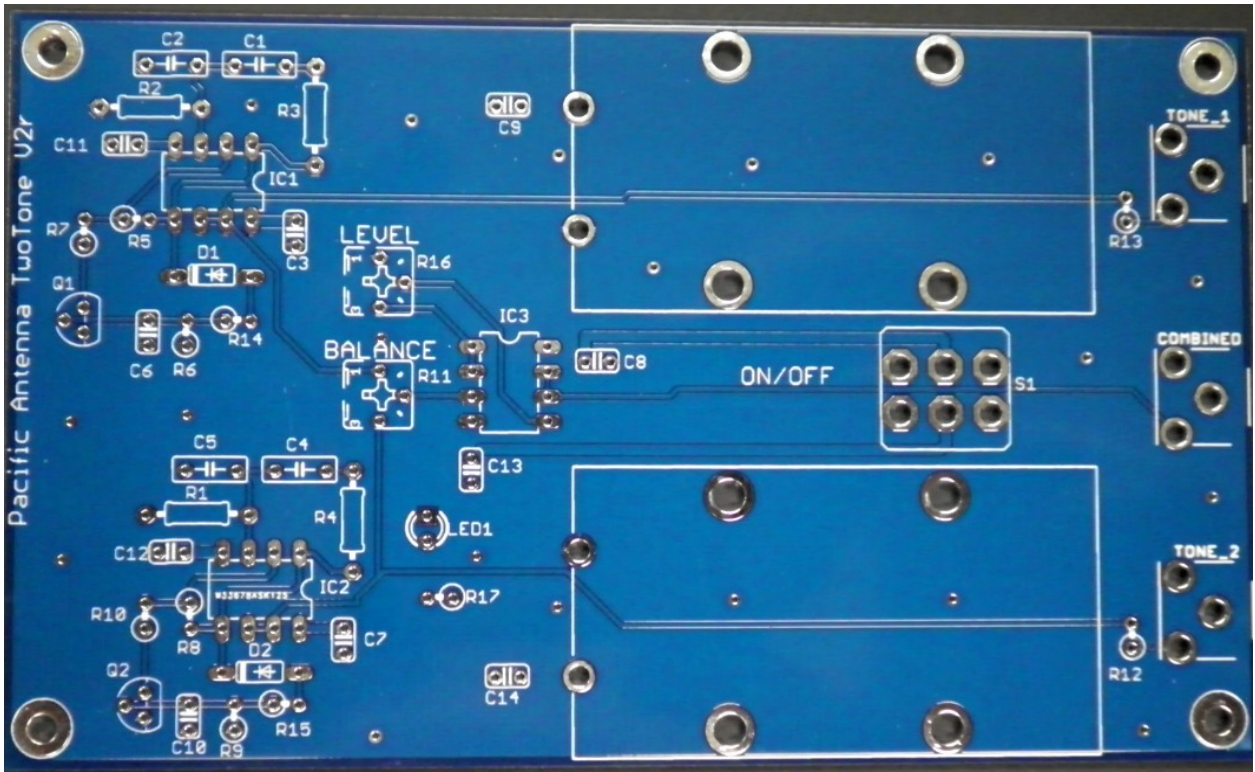

Schematic

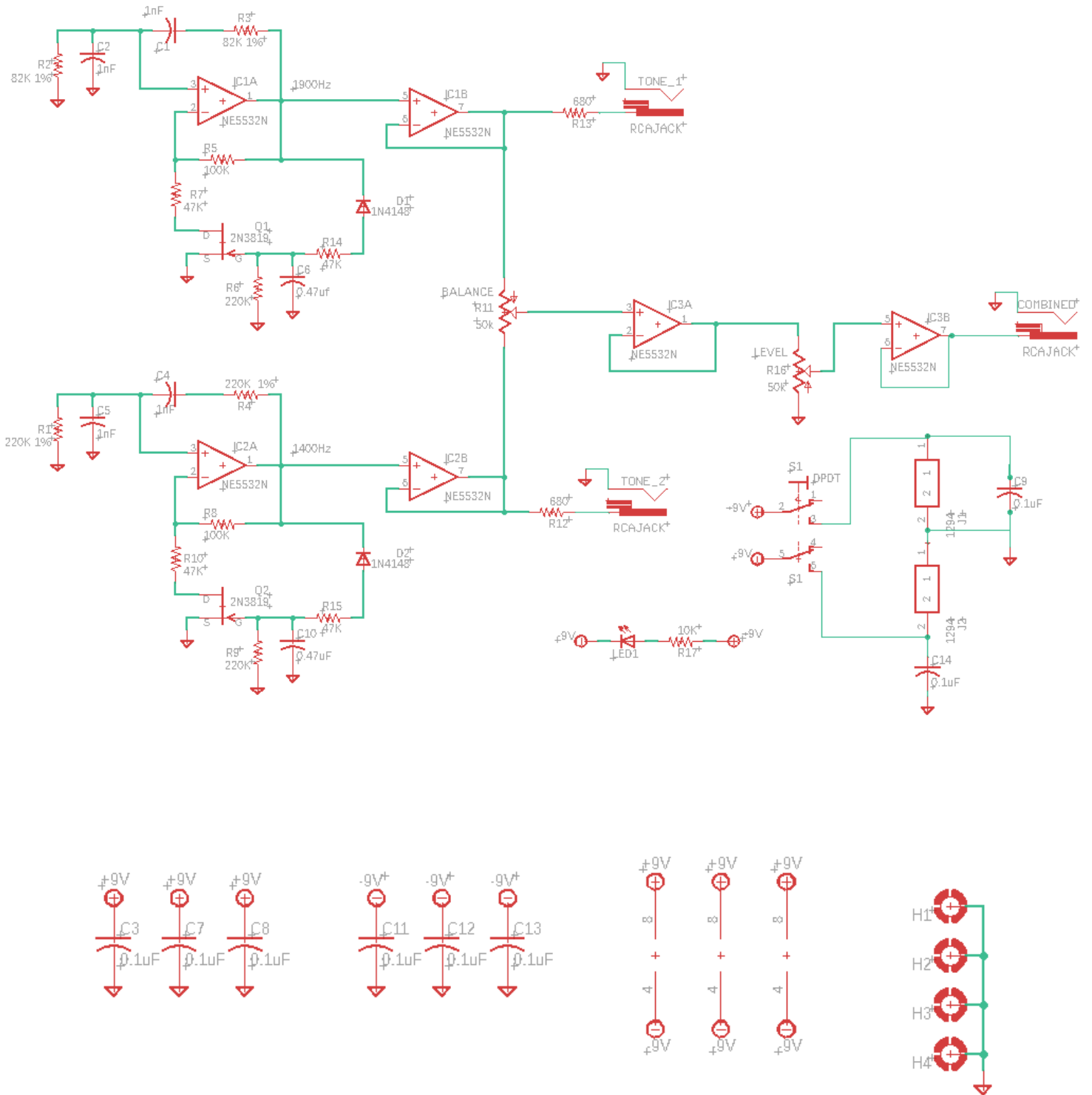

Assembly

Precision Resistors

Note: R1, R2, R3 and R4 are 1% resistors with 5 bands. They will typically have a blue body and the last band will be brown to indicate they are 1% resistors

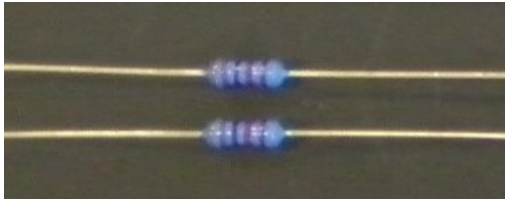

Locate and install the 82K resistors R2 and R3. They have bands that are Gray-Red-Black-Red-Brown.

These 1% resistors are installed horizontally and to prepare, bend the leads down at 90 degrees

Insert into the board, pull down to the board and then bend the leads away from each other on the bottom of the board to hold them while soldering.

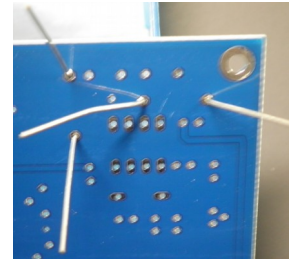

Solder one end and recheck that the resistor is seated on the board before soldering the second lead. If not, adjust before soldering.

Repeat this process for R1 and R4, the 220K 1% resistors with bands that are Red-Red-Black-Orange-Brown. Note: the kit also includes a quantity of 2, 220K 5% resistors that are used at R6 and R9. These are standard 5% resistors and should not be confused with the blue, 1% resistors.

Standard Resistors

All other resistors are marked with color bands as shown in the parts table and are installed vertically.

Double check with a multimeter if uncertain of the value.

Form the leads as shown here and insert into the board in the location marked.

Note that the body of the resistor goes into the board where there is a white ring around the pad and the lead goes into the adjacent pad.

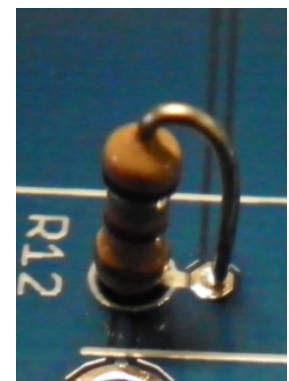
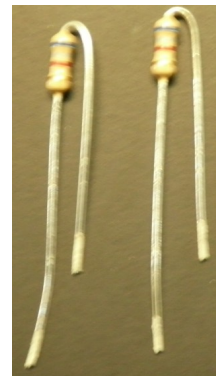

Solder one lead and recheck that the resistor is seated to the board.

If not, reheat the soldered pad and reseat before soldering the second lead.

Trimmer Potentiometers

Install R11 and R16. These are the square, blue trimpots used for Balance and Level adjustments.

They have 3 legs that will fit into the 3 offset holes in the board. The trimmers should only fit one way so make sure to orient them properly.

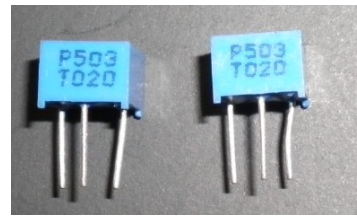

They should also sit flat on the board when fully seated.

Diodes:

Install Diodes D1 and D2 in the locations shown on the board.

These are glass packaged diodes with a band on one end. The band on the diode should match the board outline.

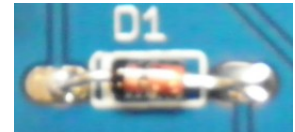
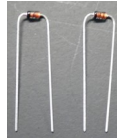

Carefully bend the leads as shown below, insert into the board and bend the leads on the back to secure in place before soldering.

Double check that the dark band on the diode body is aligned with the white band on the circuit board layout

LED:

Install the power indicator LED in the board location labeled LED1.

Note that one lead is longer than the other. The longer lead should go to the round pad and the shorter lead to the square circuit board pad as shown here:

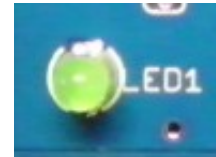
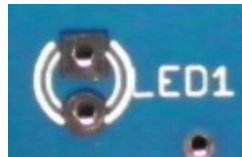

Also, to confirm the LED is inserted correctly, if you look closely, the side with the short lead also has a flat area at the base. This should be on the side with the square pad.

Capacitors:

Locate and install the 0.1uF capacitors marked 104 in locations C3, C7, C8, C9, C11, C12, C13, C14.

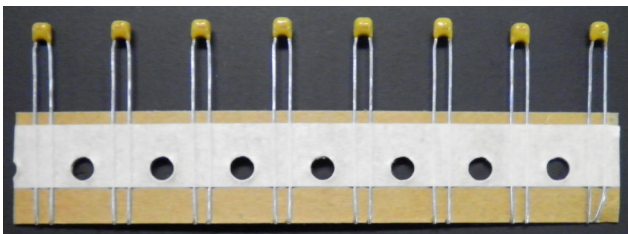

Locate and install the 0.47 μ F monolithic ceramic capacitors marked 474 in locations C6 and C10.

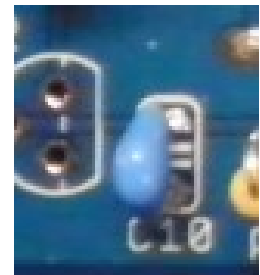
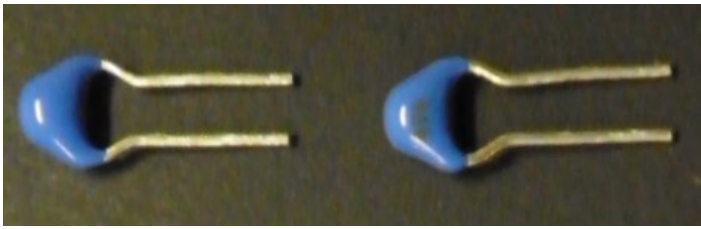

Install the 4, 1000pf (1nF) film box capacitors labeled 102 or 1000 in the locations C1, C2, C4 and C5.

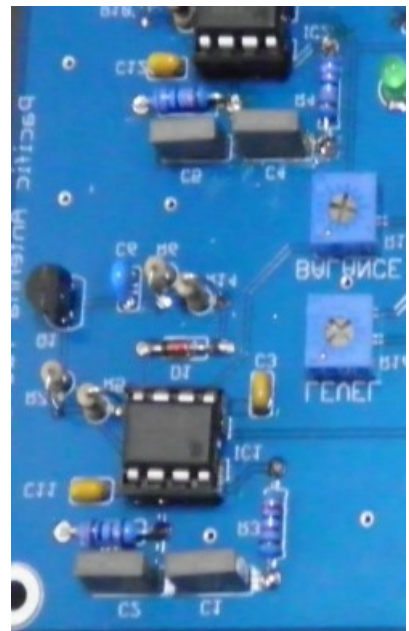
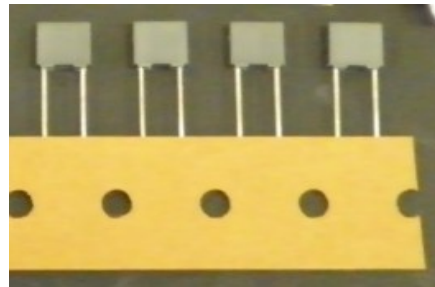

Transistors

Install Q1 and Q2 in the locations marked on the circuit board. These are 2N3819 transistors in plastic TO-92 packages and with markings as shown below:

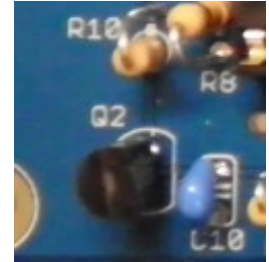
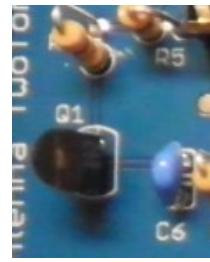
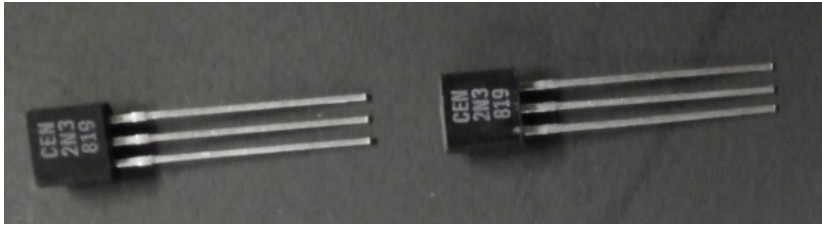

The outline of the package on the board should be used as a guide to orient the transistor.

Match the flat side and place the leads in the holes.

The center lead may need to be bent back a bit to fit the middle (offset) hole location.

Note that these parts will not fully seat to the board. It is normal for them to sit 1/8 inch or so above the board.

IC sockets

Install the 3 sockets for the ICs

Note that they have a notch on one end.

This notch should be oriented to match the outline on the circuit board.

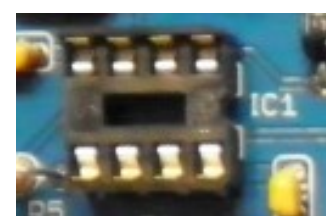
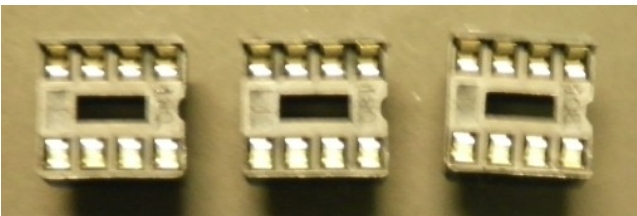

ICs

Install IC1, IC2 and IC3, into the sockets installed in the previous step, taking care to align the end with the dot to the end of the socket with the notch.

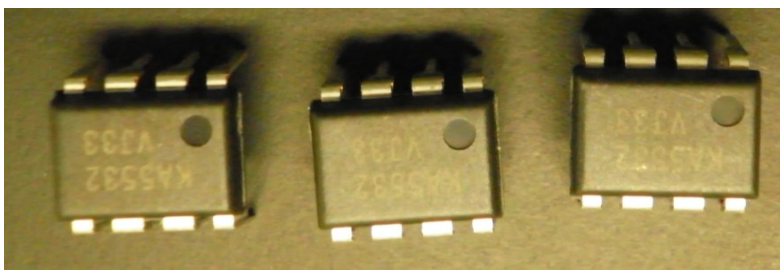

Note that you may need to form the leads on the ICs to align with the socket. If this is necessary, do so carefully to avoid breaking the IC leads.

Double check that all leads are fitting into the socket and that no leads are folded out or under the IC.

Fully seat the ICs by applying gentle pressure until they seat into the socket

Power Switch

Install the power switch S1 into the location on the circuit board.

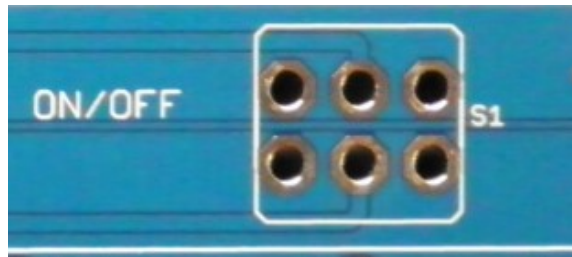

Solder one lead and if needed, reheat the solder on that pin and adjust so that the switch sits straight on the board.

Then solder the remaining leads.

RCA Jacks

Find and install the 3 RCA jacks for output signals.

It may be helpful to hold them in place with a clamp or tape to keep them from moving.

Solder only one leg and check that they are seated and straight. If not, heat the soldered connection and adjust the connector so that it correctly aligned.



There are 2 black connectors for Tone 1 and Tone 2 and a yellow connector to distinguish the combined output.



Battery Holders

Install the 2 battery holders in the locations marked.

Insert the holder leads into the board in the marked areas.

Use the supplied 4-40 screws and nuts to secure them in place and then solder and trim the leads.

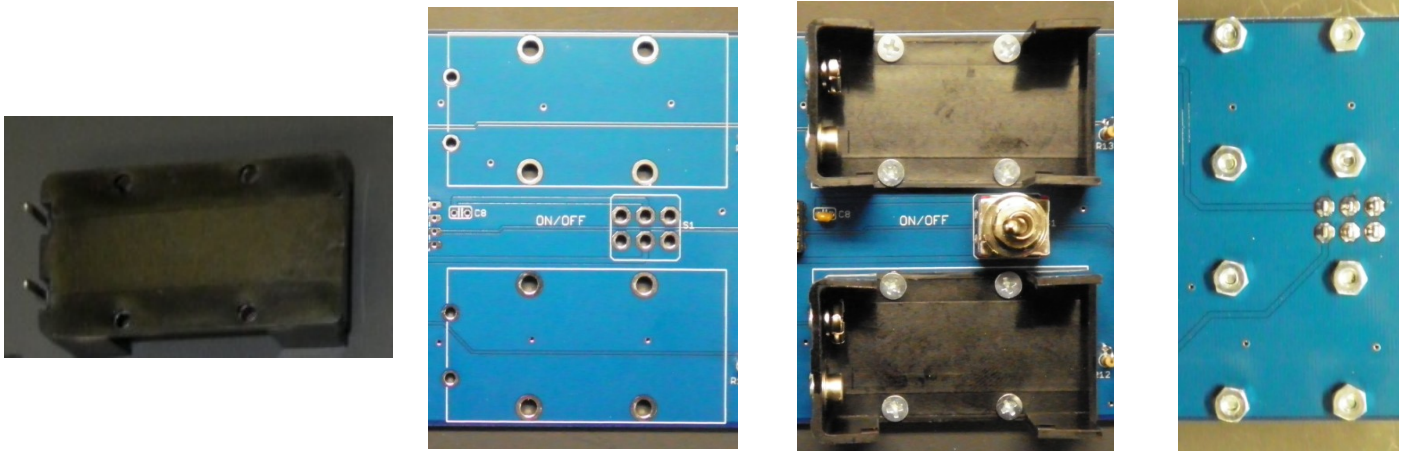

If the board is not to be placed in a case, we recommend installing the rubber feet on the bottom of the board to help avoid shorts and damage to the circuit board or tabletop.

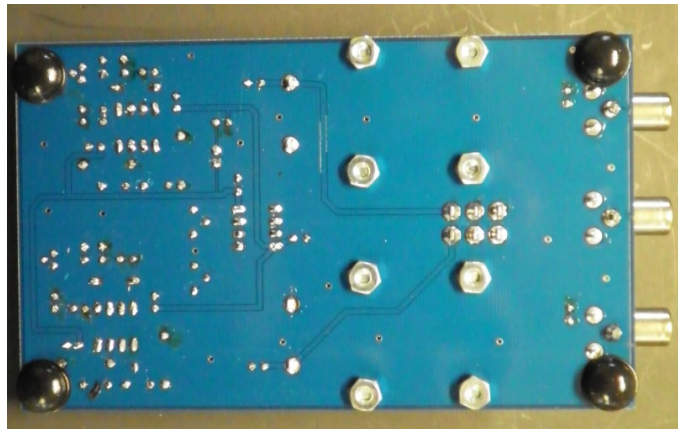

Congratulations!
This completes assembly of your Two Tone Generator Kit

Testing

Inspect the board for correct component installation paying special attention to the ICs, transistors and diodes.

Inspect the solder pad side for missed solder joints, or other bad solder joints and shorts and resolder if needed.

Install 2 fresh 9V batteries in the battery holders, observing correct polarity.

Turn on the switch S1 and observe that the LED glows.

If not, recheck the battery installation and solder connections and the LED orientation.

The LED has a slightly flat side on the short lead side and the flat should be on the same side as the square pad.

Using a multimeter on a voltage range sufficient to measure up to 20VDC, check the following by measuring between the corresponding pin and one of the grounded mounting hole pads at the board corners:

Voltages at Pin 4 of ICs 1, 2, and 3 should be approximately -9V to ground with a fresh battery

Voltages at Pin 8 of ICs 1, 2 and 3 should be approximately +9V to ground with a fresh battery

Voltage from pin 4 to pin 8 should show approximately twice the battery voltage.

Connect an oscilloscope and frequency counter to Tone 1. Check that the frequency is approximately 1900Hz and the output a clean sine wave of approximately 4-5Vpp.

Repeat this check for Tone 2 and verify a frequency of approximately 750Hz.

Connect the Oscilloscope to the Combined output and observe the waveform as you vary the Balance and Level trimmers.

By varying the balance pot, you should be able to vary the waveform from the high to the low frequency sine wave with a mixture of the two in between.

By varying the Level trimpot, you should be able to vary the output level from less than 1mVpp to over 8Vpp.

If all of these checks pass, the TwoTone generator is ready to use.

A BNC to RCA adapter is included.

Depending on your application, additional adapters or cables may be needed.

Note: Power switch should be switched to off to prevent battery drain when not in use.

Thank you for purchasing our TwoTone Generator Kit!

Support: qrpkits.com@gmail.com